DISCRETE POWER DIODES and THYRISTORS
DATA BOOK

PHASE CONTROL THYRISTORS

Stud Version

Features

- Center amplifying gate
- Hermetic metal case with ceramic insulator
(Also available with glass-metal seal up to 1200V)
- International standard case TO-209AB (TO-93)
- Threaded studs UNF 3/4 - 16UNF2A or ISO M16x1.5
- Compression Bonded Encapsulation for heavy duty operations such as severe thermal cycling

200A

Typical Applications

- DC motor controls
- Controlled DC power supplies
- AC controllers

Major Ratings and Characteristics

Parameters	ST180S	Units
$I_{T(AV)}$	200	A
@ T_C	85	°C
$I_{T(RMS)}$	314	A
I_{TSM} @ 50Hz	5000	A
@ 60Hz	5230	A
I^2t @ 50Hz	125	KA ² s
@ 60Hz	114	KA ² s
V_{DRM}/V_{RRM}	400 to 2000	V
t_q typical	100	μs
T_J	- 40 to 125	°C

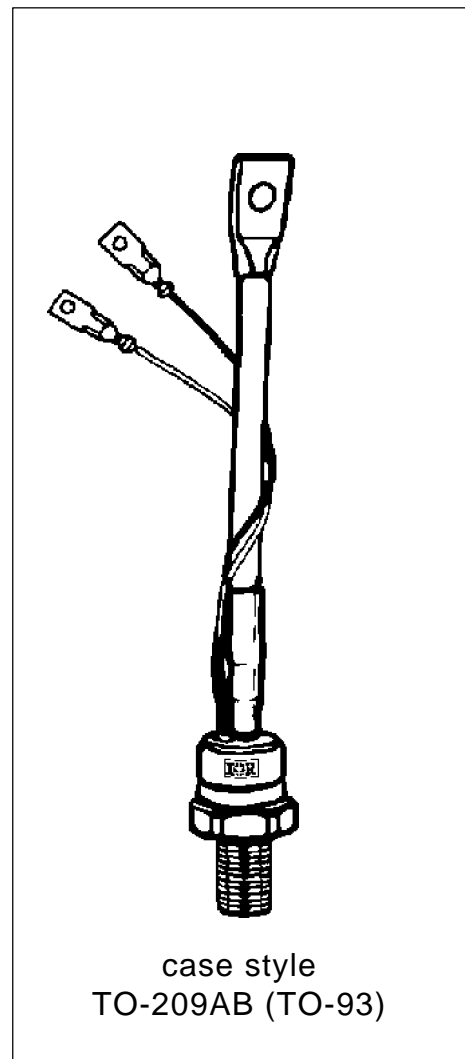

ST180S Series

ELECTRICAL SPECIFICATIONS

Voltage Ratings

Type number	Voltage Code	V_{DRM}/V_{RRM} , max. repetitive peak and off-state voltage V	V_{RSM} , maximum non-repetitive peak voltage V	I_{DRM}/I_{RRM} max. @ $T_J = T_J$ max mA
ST180S	04	400	500	30
	08	800	900	
	12	1200	1300	
	16	1600	1700	
	18	1800	1900	
	20	2000	2100	

On-state Conduction

Parameter	ST180S	Units	Conditions
$I_{T(AV)}$ Max. average on-state current @ Case temperature	200	A	180° conduction, half sine wave
	85	°C	
$I_{T(RMS)}$ Max. RMS on-state current	314	A	DC @ 76°C case temperature
I_{TSM} Max. peak, one-cycle non-repetitive surge current	5000	A	t = 10ms No voltage
	5230		t = 8.3ms reapplied
	4200		t = 10ms 100% V_{RRM}
	4400		t = 8.3ms reapplied
I^2t Maximum I^2t for fusing	125	KA ² s	t = 10ms No voltage
	114		t = 8.3ms reapplied
	88		t = 10ms 100% V_{RRM}
	81		t = 8.3ms reapplied
$I^2\sqrt{t}$ Maximum $I^2\sqrt{t}$ for fusing	1250	KA ² √s	t = 0.1 to 10ms, no voltage reapplied
$V_{T(TO)1}$ Low level value of threshold voltage	1.08	V	$(16.7\% \times \pi \times I_{T(AV)} < I < \pi \times I_{T(AV)})$, $T_J = T_J$ max.
$V_{T(TO)2}$ High level value of threshold voltage	1.14		$(I > \pi \times I_{T(AV)})$, $T_J = T_J$ max.
r_{t1} Low level value of on-state slope resistance	1.18	mΩ	$(16.7\% \times \pi \times I_{T(AV)} < I < \pi \times I_{T(AV)})$, $T_J = T_J$ max.
r_{t2} High level value of on-state slope resistance	1.14		$(I > \pi \times I_{T(AV)})$, $T_J = T_J$ max.
V_{TM} Max. on-state voltage	1.75	V	$I_{pk} = 570A$, $T_J = 125^\circ C$, $t_p = 10ms$ sine pulse
I_H Maximum holding current	600	mA	$T_J = T_J$ max, anode supply 12V resistive load
I_L Max. (typical) latching current	1000 (300)		

Switching

Parameter	ST180S	Units	Conditions
di/dt Max. non-repetitive rate of rise of turned-on current	1000	A/μs	Gate drive 20V, 20Ω, $t_r \leq 1\mu s$ $T_J = T_J$ max, anode voltage $\leq 80\% V_{DRM}$
t_d Typical delay time	1.0	μs	Gate current 1A, $di_g/dt = 1A/\mu s$ $V_d = 0.67\% V_{DRM}$, $T_J = 25^\circ C$
t_q Typical turn-off time	100		$I_{TM} = 300A$, $T_J = T_J$ max, $di/dt = 20A/\mu s$, $V_R = 50V$ $dv/dt = 20V/\mu s$, Gate 0V 100Ω, $t_p = 500\mu s$

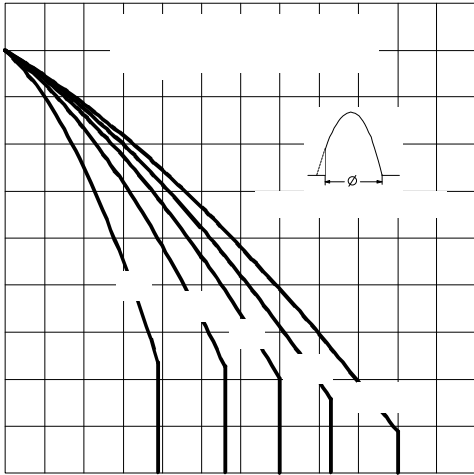

Fig. 1 - Current Ratings Characteristics

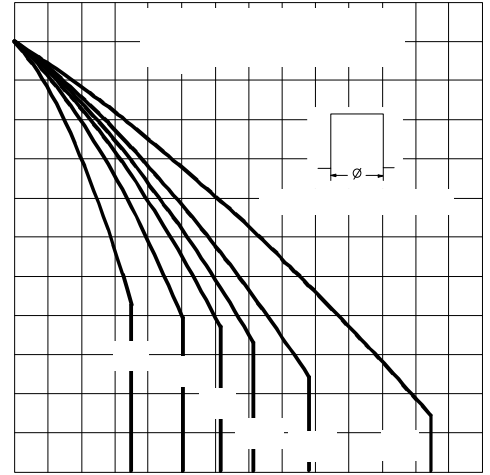

Fig. 2 - Current Ratings Characteristics

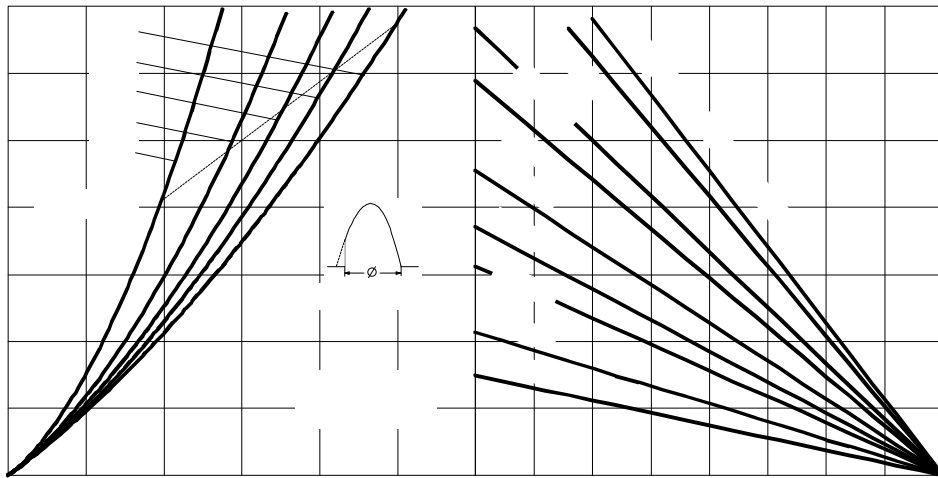
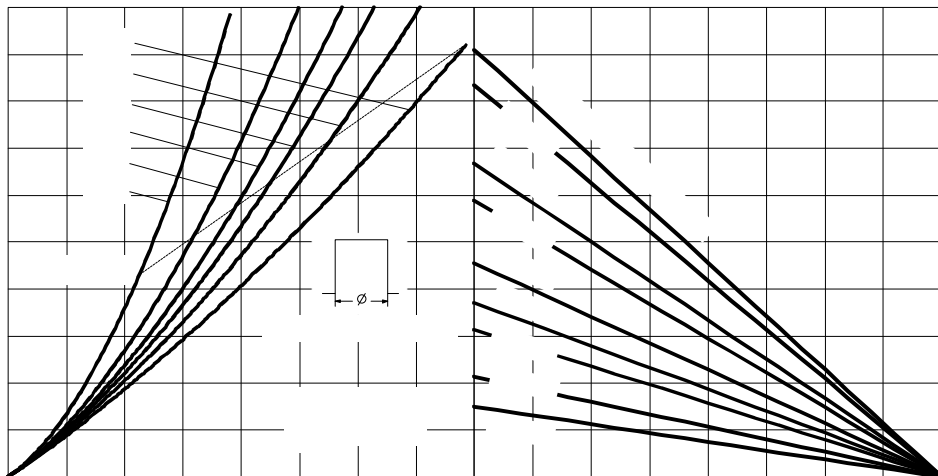

Fig. 3 - On-state Power Loss Characteristics



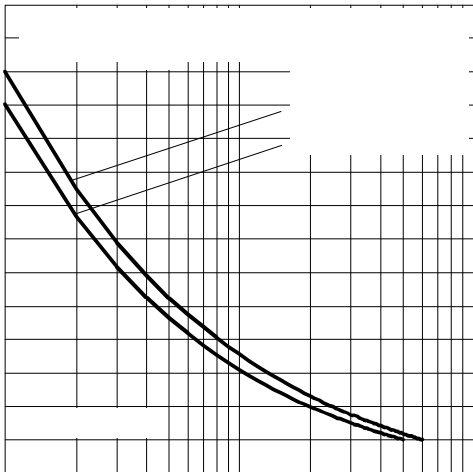

Fig. 5 - Maximum Non-Repetitive Surge Current

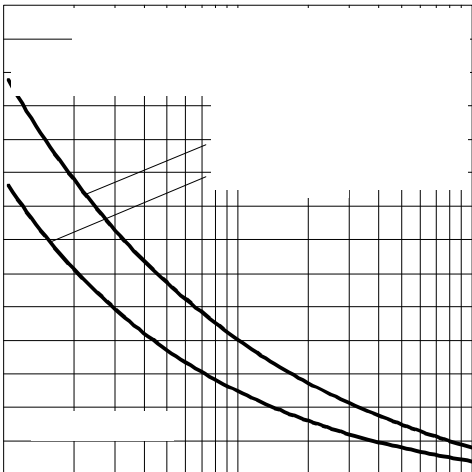

Fig. 6 - Maximum Non-Repetitive Surge Current

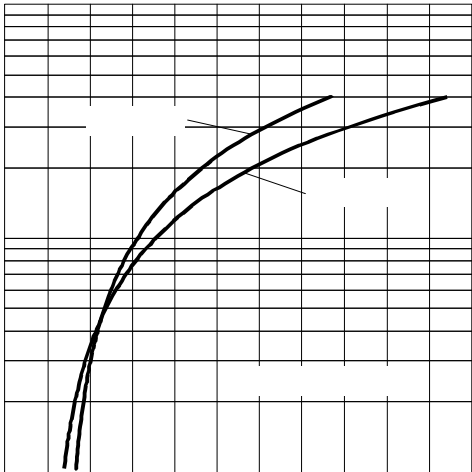

Fig. 7 - On-state Voltage Drop Characteristics

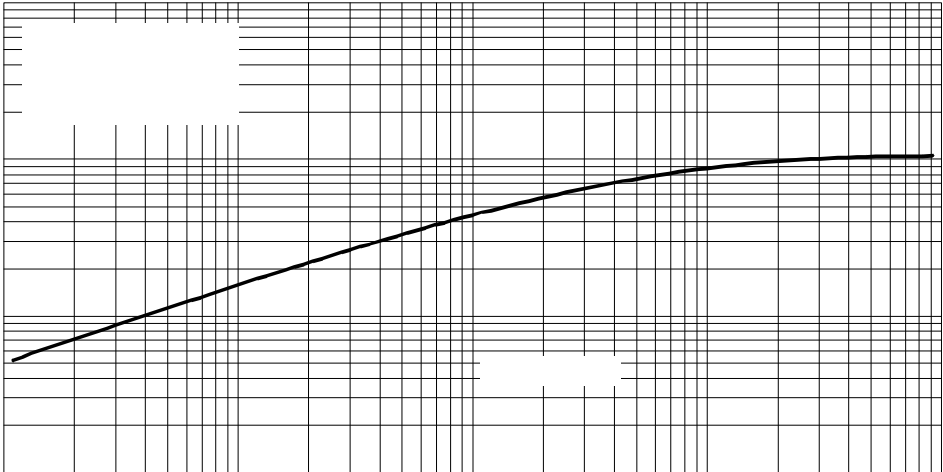

Fig. 8 - Thermal Impedance Z_{thJC} Characteristic

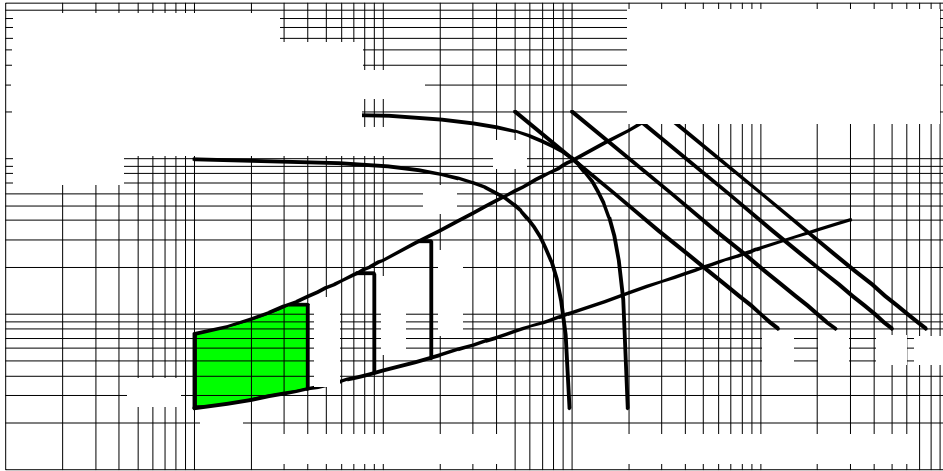

Fig. 9 - Gate Characteristics

Blocking

Parameter	ST180S	Units	Conditions
dv/dt Maximum critical rate of rise of off-state voltage	500	V/ μ s	$T_J = T_J$ max linear to 80% rated V_{DRM}
I_{DRM} I_{RRM} Max. peak reverse and off-state leakage current	30	mA	$T_J = T_J$ max, rated V_{DRM}/V_{RRM} applied

Triggering

Parameter	ST180S	Units	Conditions	
P_{GM} Maximum peak gate power	10	W	$T_J = T_J$ max, $t_p \leq 5$ ms	
$P_{G(AV)}$ Maximum average gate power	2.0		$T_J = T_J$ max, $f = 50$ Hz, $d\% = 50$	
I_{GM} Max. peak positive gate current	3.0	A	$T_J = T_J$ max, $t_p \leq 5$ ms	
$+V_{GM}$ Maximum peak positive gate voltage	20	V	$T_J = T_J$ max, $t_p \leq 5$ ms	
$-V_{GM}$ Maximum peak negative gate voltage	5.0			
I_{GT} DC gate current required to trigger	TYP.	MAX.	$T_J = -40^\circ\text{C}$ $T_J = 25^\circ\text{C}$ $T_J = 125^\circ\text{C}$ Max. required gate trigger/ current/ voltage are the lowest value which will trigger all units 12V anode-to-cathode applied	
	180	-		mA
	90	150		
V_{GT} DC gate voltage required to trigger	2.9	-	$T_J = -40^\circ\text{C}$ $T_J = 25^\circ\text{C}$ $T_J = 125^\circ\text{C}$	
	1.8	3.0		V
	1.2	-		
I_{GD} DC gate current not to trigger	10	mA	$T_J = T_J$ max Max. gate current/ voltage not to trigger is the max. value which will not trigger any unit with rated V_{DRM} anode-to-cathode applied	
V_{GD} DC gate voltage not to trigger	0.25	V		

Thermal and Mechanical Specification

Parameter	ST180S	Units	Conditions
T_J Max. operating temperature range	-40 to 125	$^\circ\text{C}$	
T_{stg} Max. storage temperature range	-40 to 150		
R_{thJC} Max. thermal resistance, junction to case	0.105	K/W	DC operation
R_{thCS} Max. thermal resistance, case to heatsink	0.04		Mounting surface, smooth, flat and greased
T Mounting torque, $\pm 10\%$	31 (275)	Nm (lbf-in)	Non lubricated threads
	24.5 (210)		Lubricated threads
wt Approximate weight	280	g	
Case style	TO - 209AB (TO-93)		See Outline Table

ΔR_{thJC} Conduction

(The following table shows the increment of thermal resistance R_{thJC} when devices operate at different conduction angles than DC)

Conduction angle	Sinusoidal conduction	Rectangular conduction	Units	Conditions
180°	0.015	0.012	K/W	$T_J = T_{J \text{ max.}}$
120°	0.019	0.020		
90°	0.025	0.027		
60°	0.036	0.037		
30°	0.060	0.060		

Ordering Information Table

Device Code

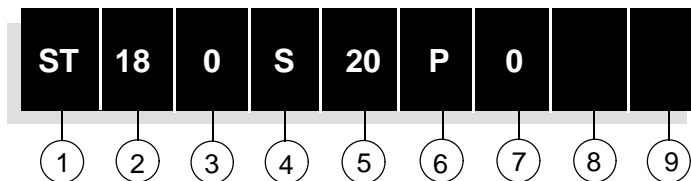

- 1** - Thyristor
- 2** - Essential part number
- 3** - 0 = Converter grade
- 4** - S = Compression bonding Stud
- 5** - Voltage code: Code x 100 = V_{RRM} (See Voltage Rating Table)
- 6** - P = Stud base 16UNF threads
M = Stud base metric threads (M16 x 1.5)
- 7** - 0 = Eyelet terminals (Gate and Auxiliary Cathode Leads)
1 = Fast - on terminals (Gate and Auxiliary Cathode Leads)
2 = Flag terminals (For Cathode and Gate Terminals)
- 8** - V = Glass-metal seal (only up to 1200V)
None = Ceramic housing (over 1200V)
- 9** - Critical dv/dt: None = 500V/ μ sec (Standard value)
L = 1000V/ μ sec (Special selection)

Outline Table

GLASS METAL SEAL

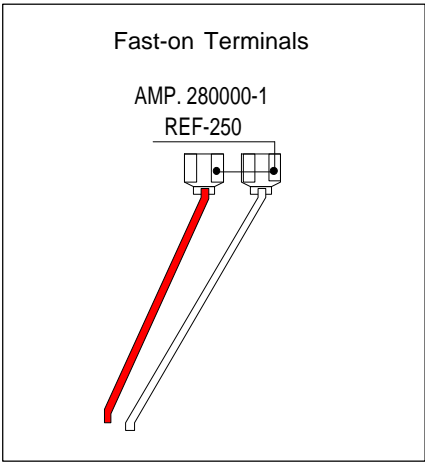
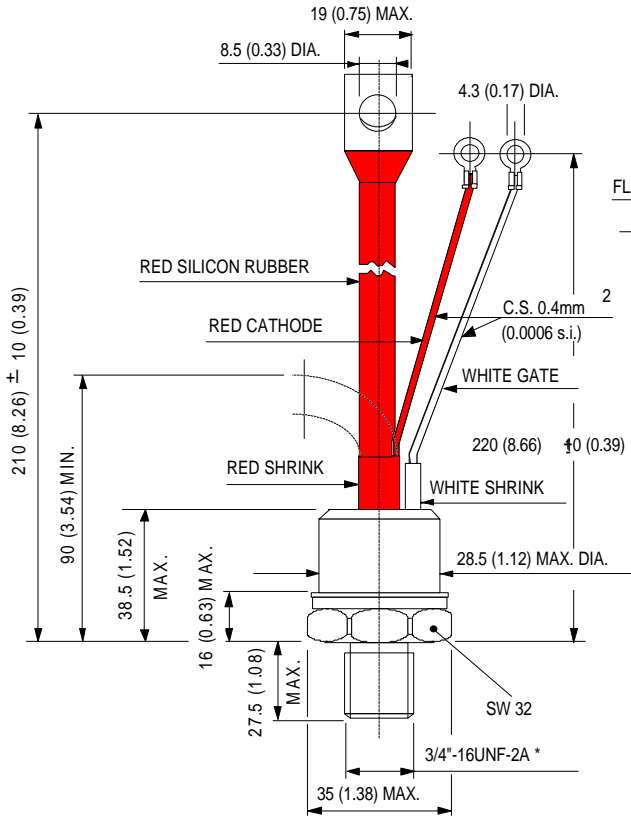

Case Style TO-209AB (TO-93)

All dimensions in millimeters (inches)

* FOR METRIC DEVICE : M16 x 1.5 - LENGHT 21 (0.83) MAX.

CERAMIC HOUSING

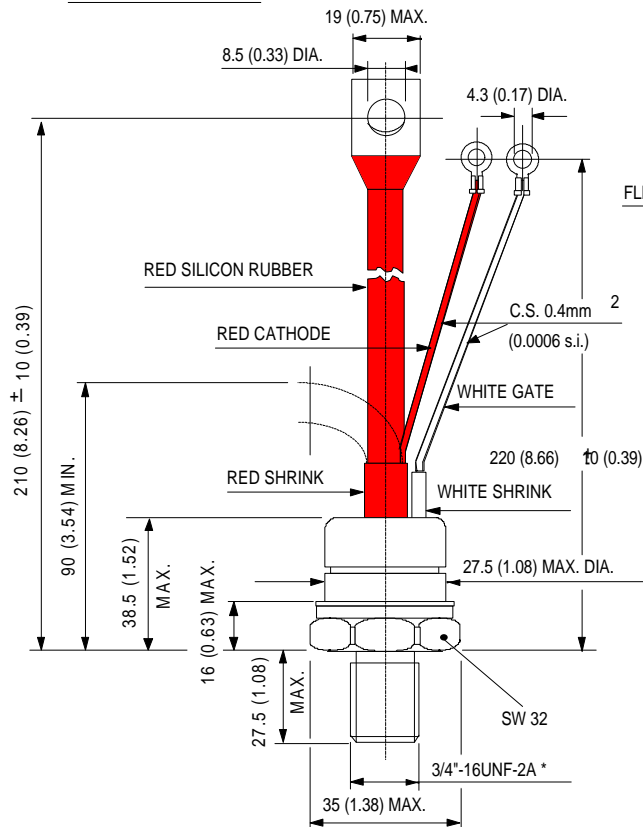

* FOR METRIC DEVICE : M16 x 1.5 - LENGHT 21 (0.83) MAX.

Outline Table

GLASS-METAL SEAL FLAG TERMINALS

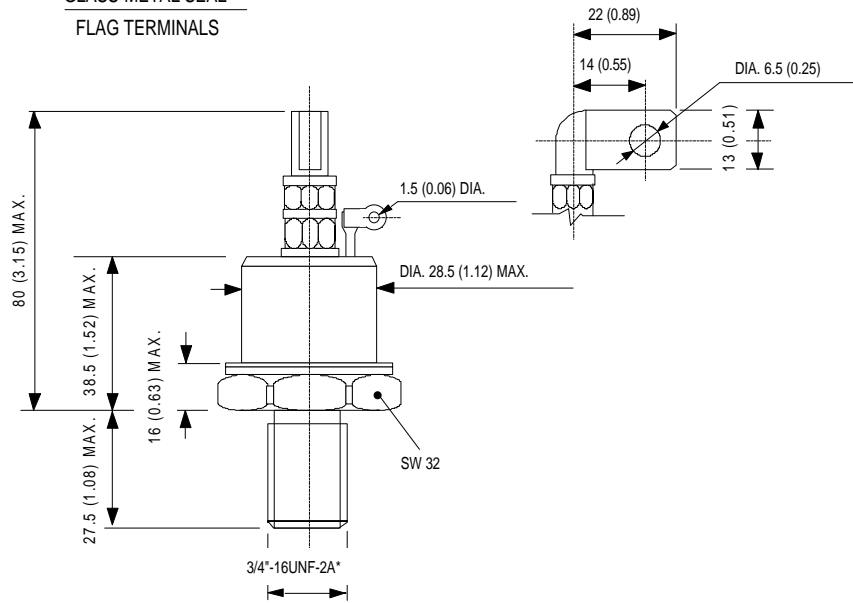

*FOR METRIC DEVICE. M16 X 1.5 - LENGHT 21 (0.83) MAX.

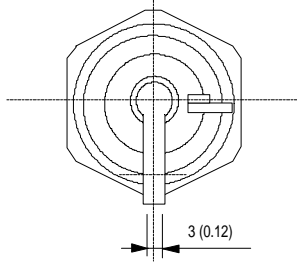

Case Style TO-209AB (TO-93) Flag
All dimensions in millimeters (inches)

CERAMIC HOUSING FLAG TERMINALS

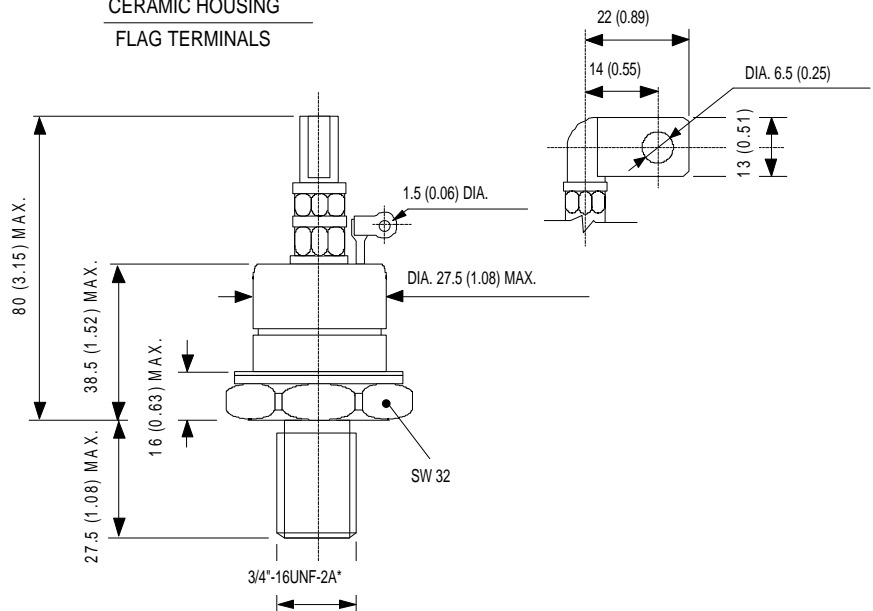

*FOR METRIC DEVICE. M16 X 1.5 - LENGHT 21 (0.83) MAX.

